

Partdrawing for GA008GZ - Haakse slijper

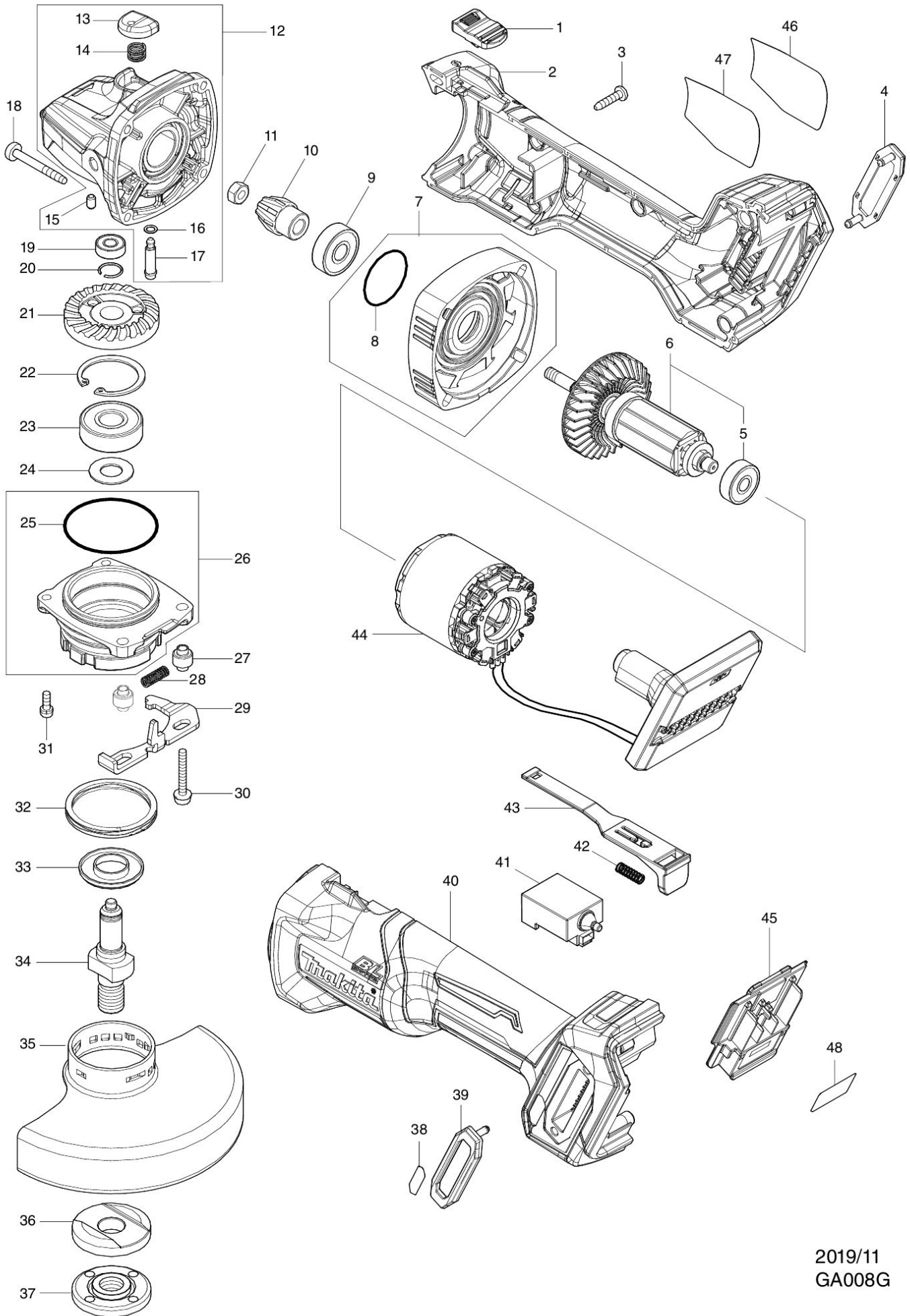

2019/11
GA008G