

Partdrawing for GA013GM201 - Haakse slijper

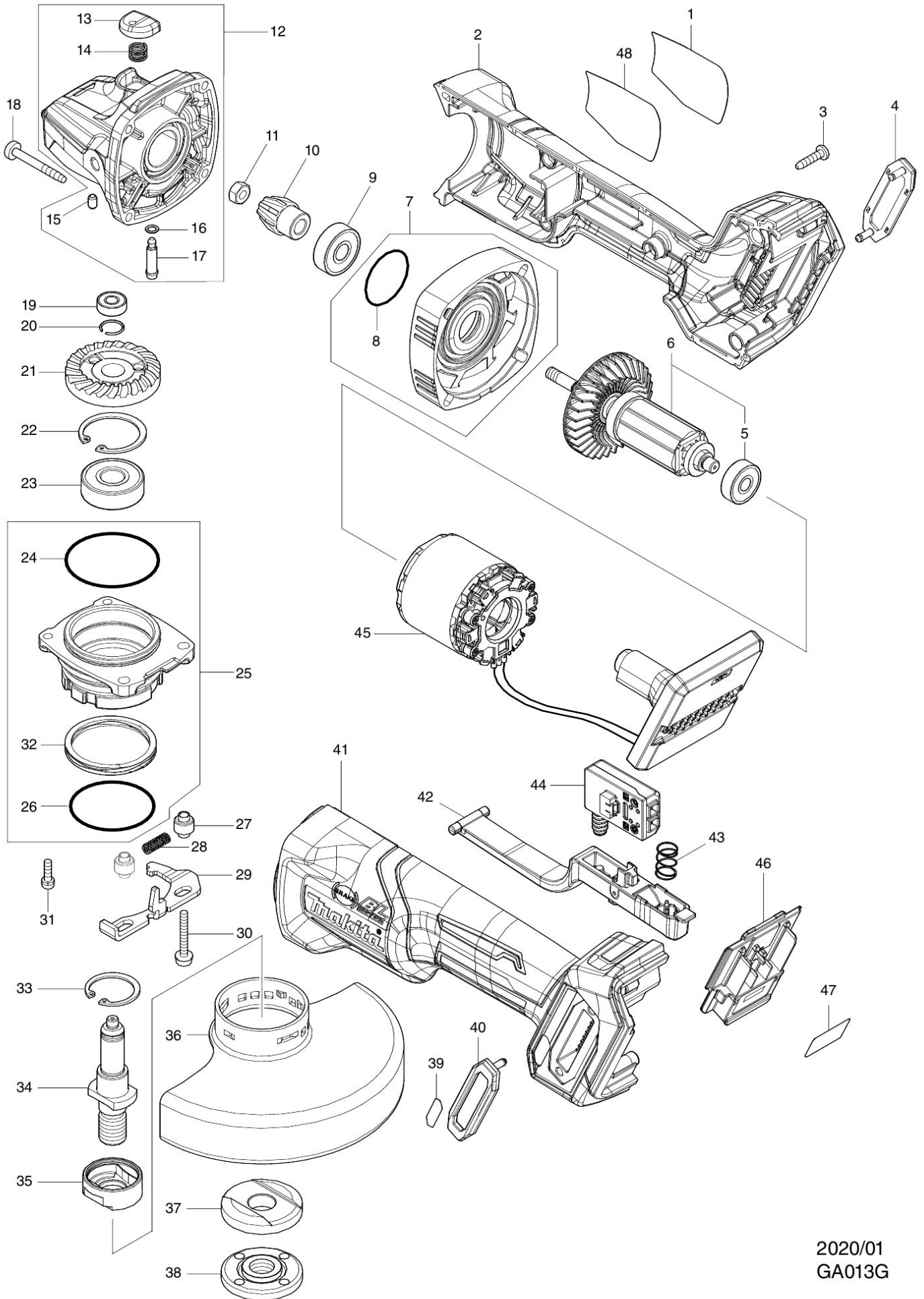

2020/01
GA013G