

# Partdrawing for GA016GM201 - Haakse slijper

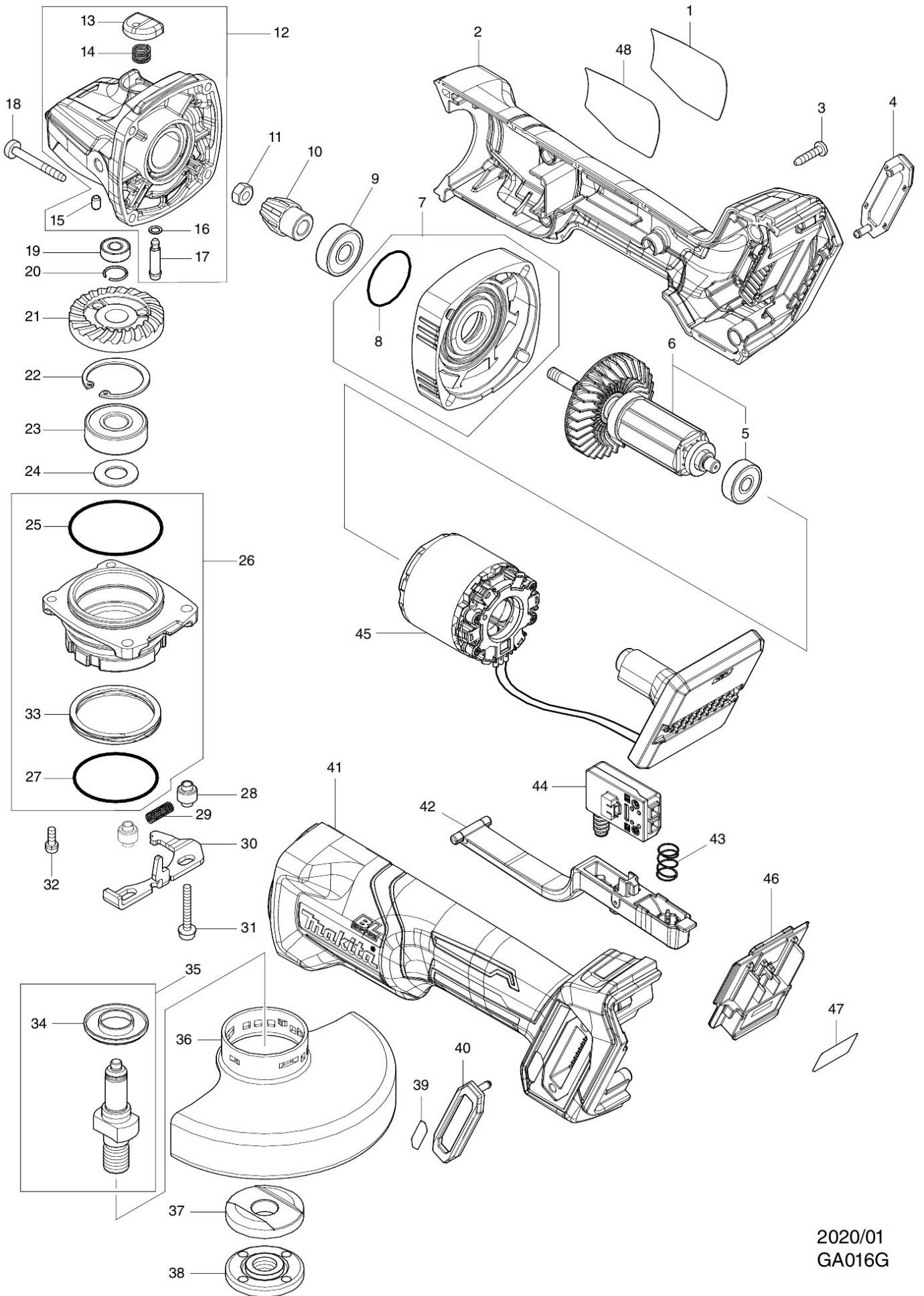

2020/01  
GA016G