

Partdrawing for GA026GZ - Haakse slijper

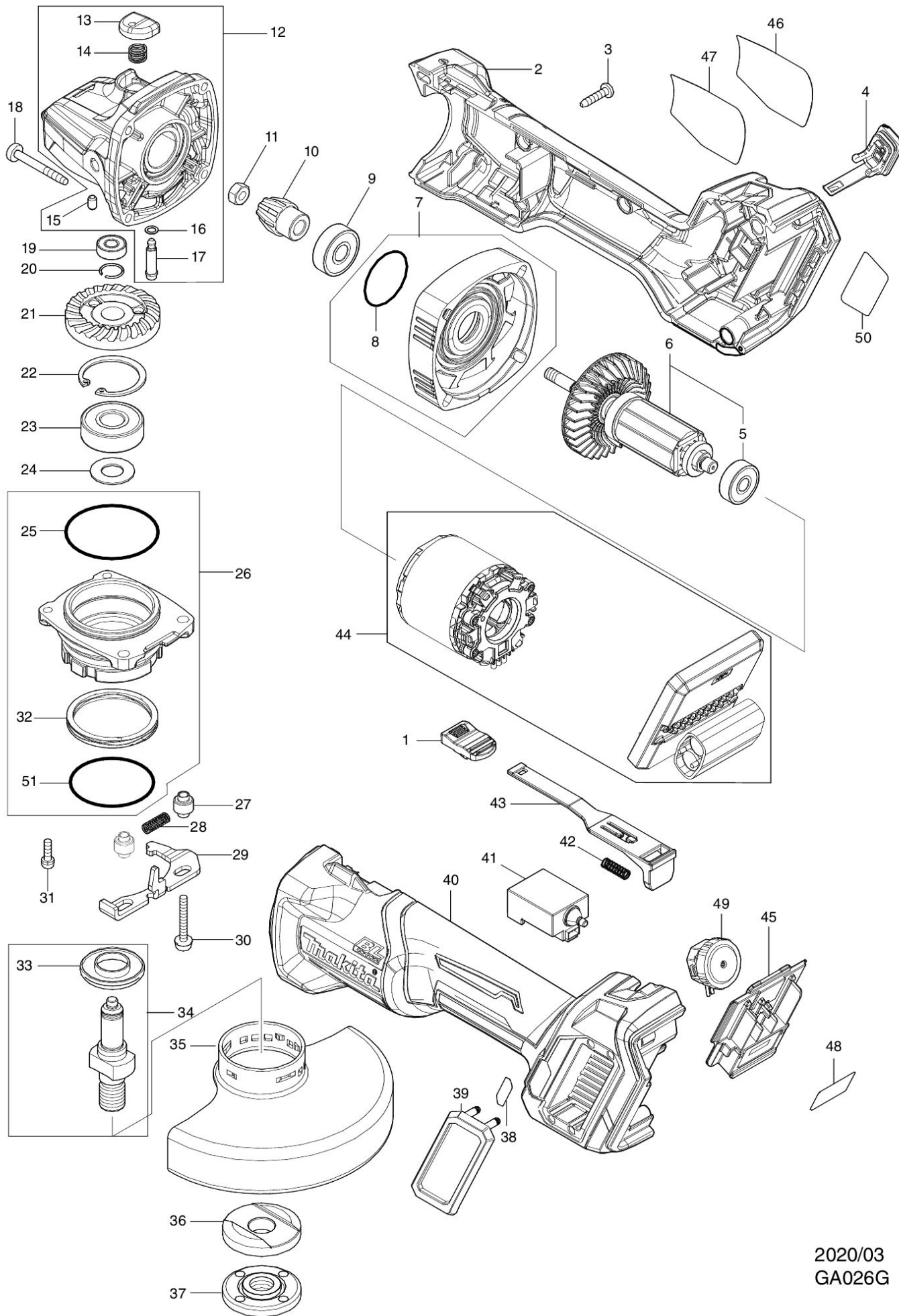

2020/03
GA026G