

Partdrawing for GA032GM201 - Haakse slijper

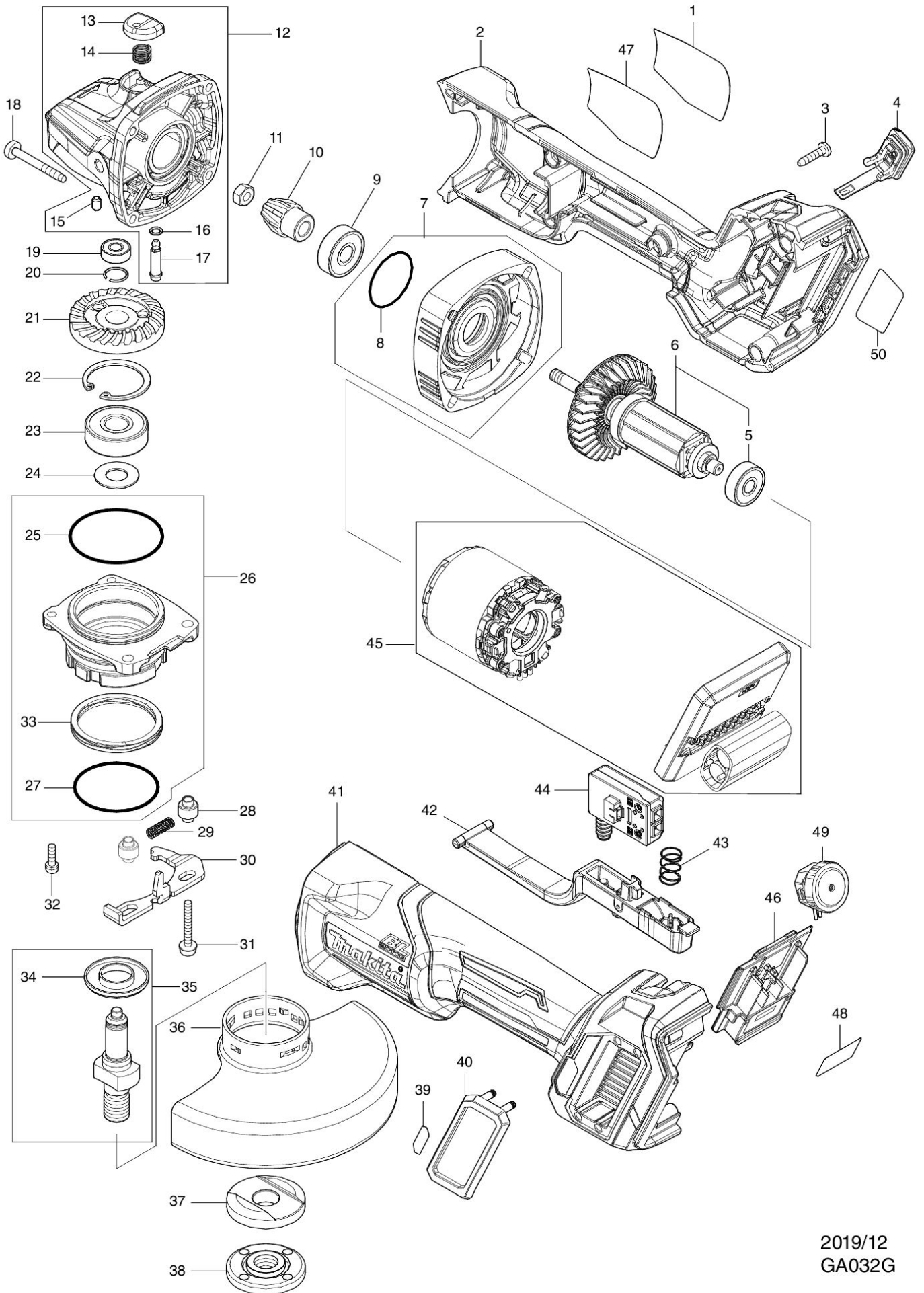

2019/12
GA032G