

# Partdrawing for GA032GZ - Haakse slijper

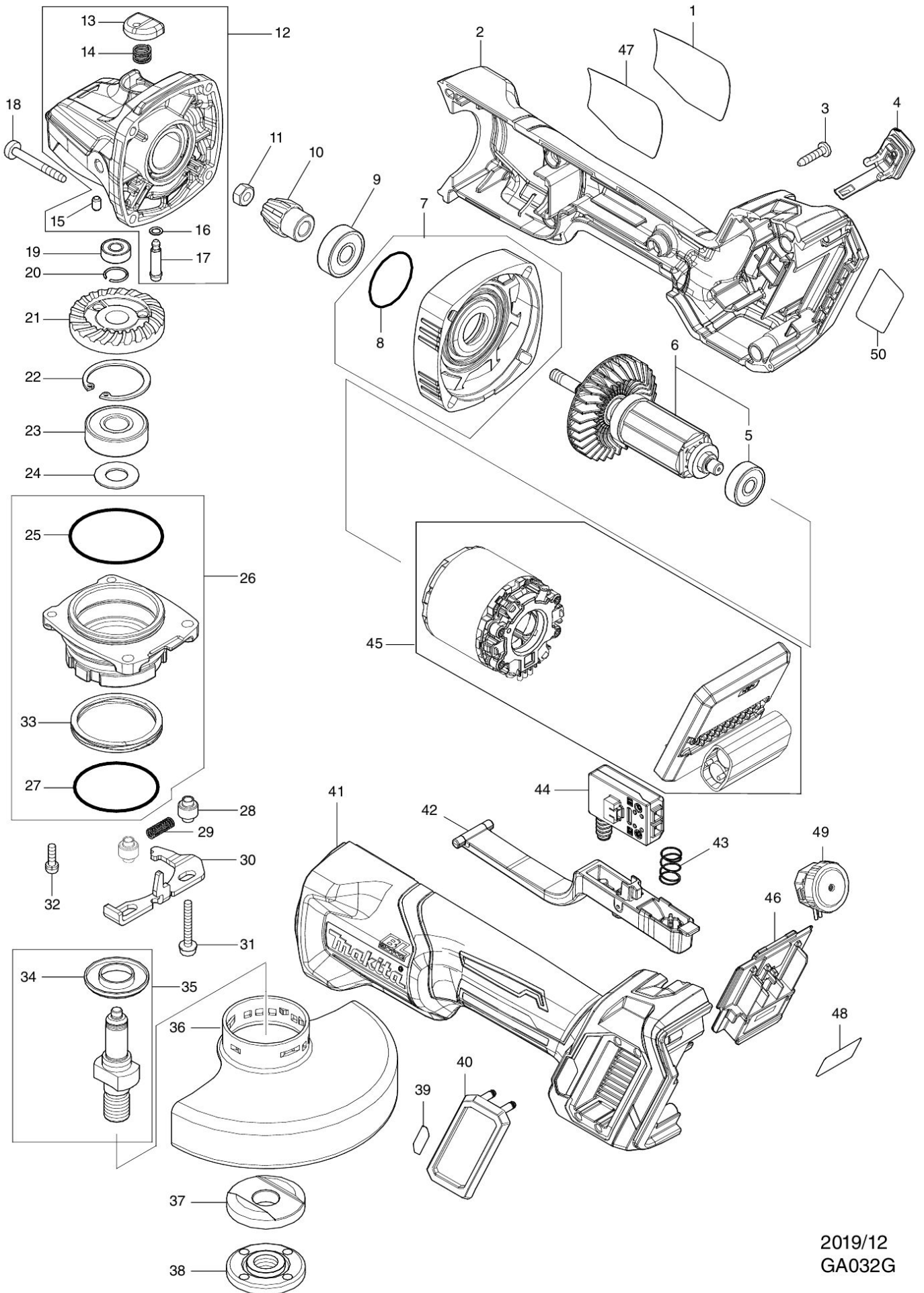

2019/12  
GA032G