

Partdrawing for DCL282FZB - Steelstofzuiger

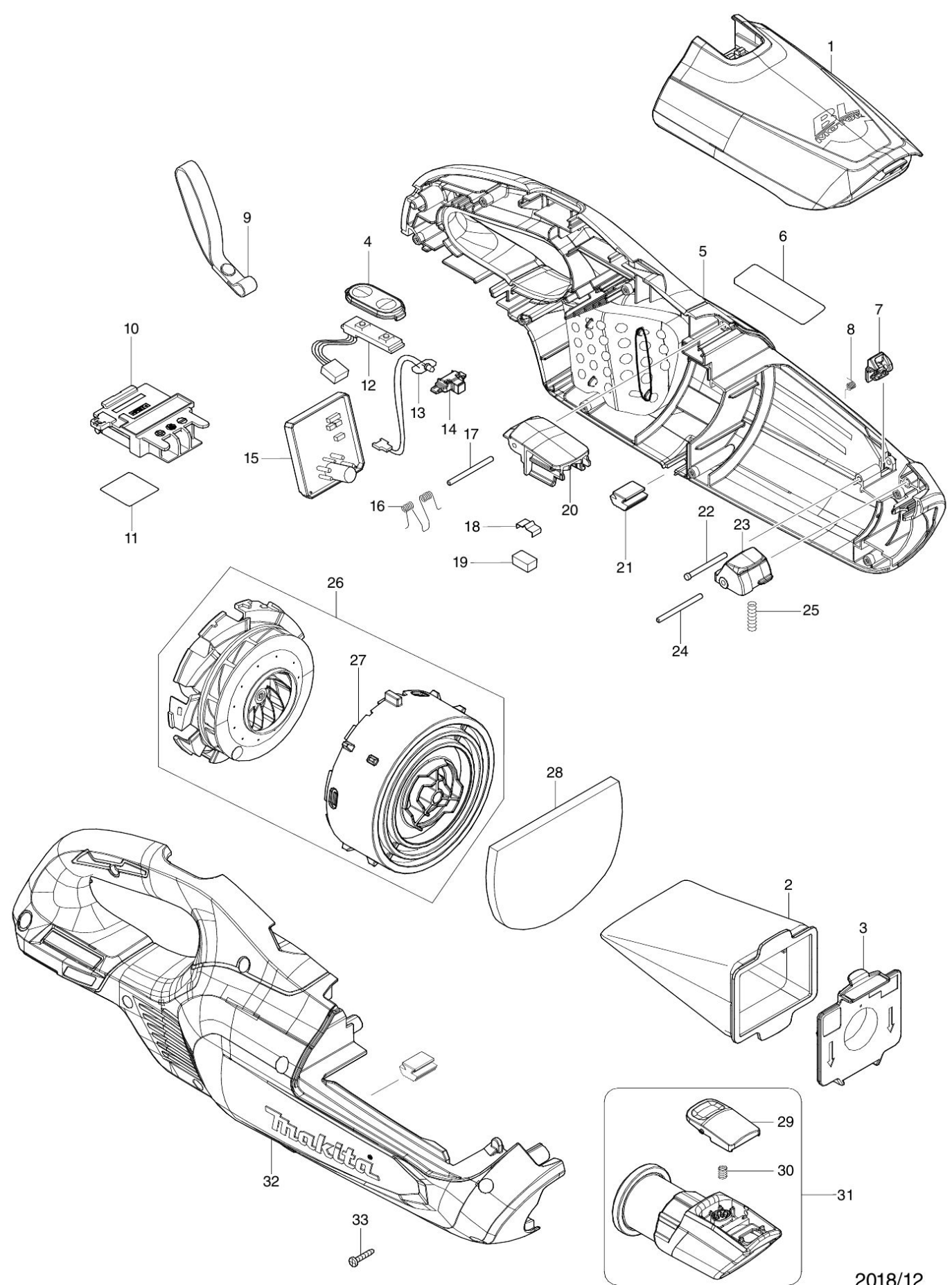

2018/12
DCL282F